

tielock®

USE THE BEST

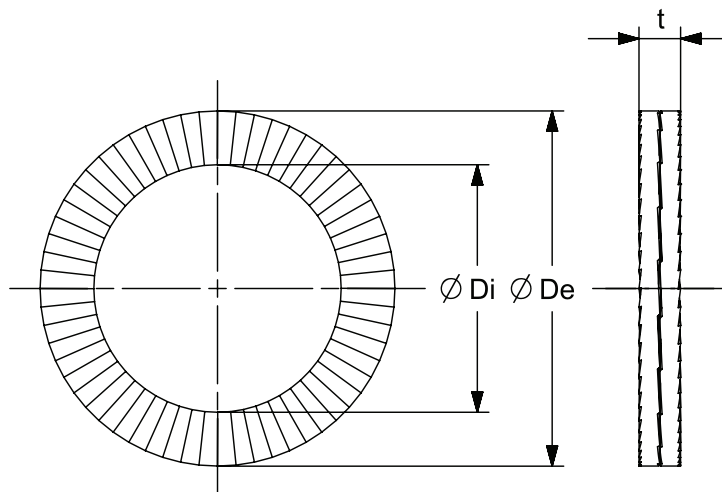
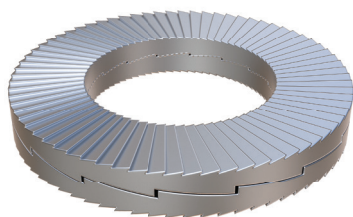

Technical Specifications

Product Name	Twinwashers	TW22SP
Product Code	Item Number	2027
VPE	Number Per Package	50 Pcs.
	Materials	Steel EN 1.7182
De	Outer Diameter (mm)	42,00
Di	Inner Diameter (mm)	23,40
t	Material Thickness (mm)	4,60

Standart
DIN 25201

Alternative Materials
Steel EN 1.7182
Stainless Steel EN 1.4404

