

tielock®

USE THE BEST

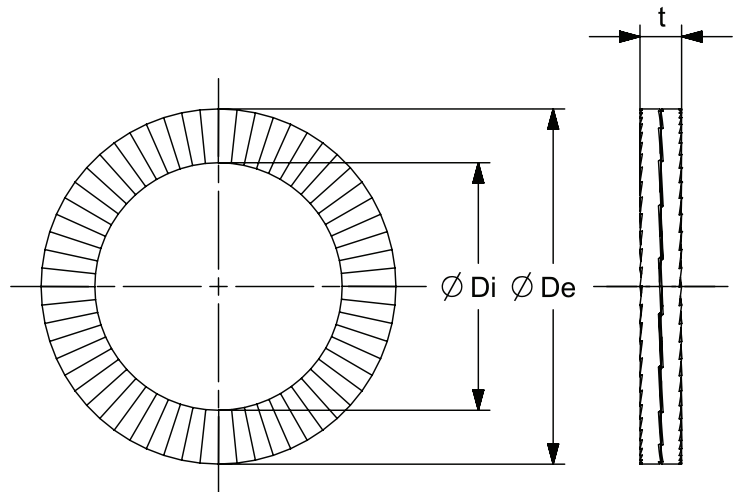
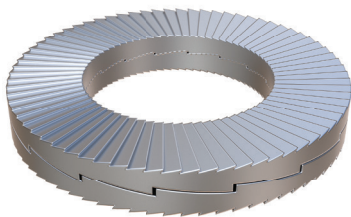

Technical Specifications

Product Name	Twinwashers	TW90
Product Code	Item Number	2053
VPE	Number Per Package	1 Pcs.
	Materials	Steel EN 1.7182
De	Outer Diameter (mm)	130,0
Di	Inner Diameter (mm)	92,4
t	Material Thickness (mm)	9,5

Standart
DIN 25201

Alternative Materials
Steel EN 1.7182
Stainless Steel EN 1.4404

