

tielock®

USE THE BEST

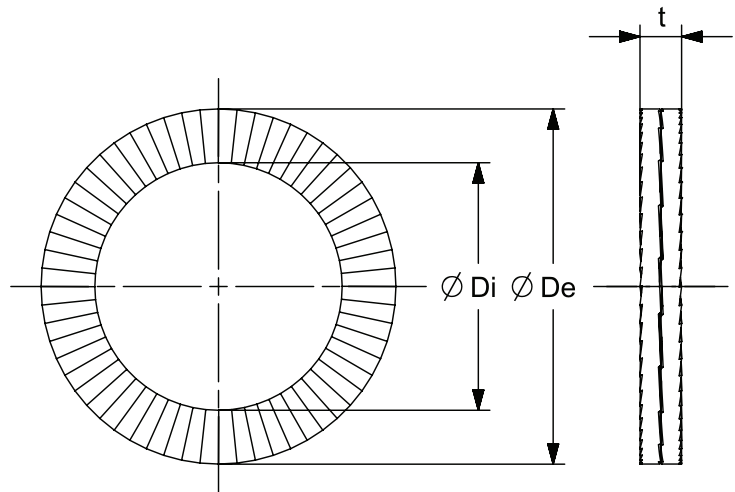
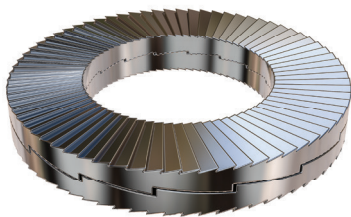

Technical Specifications

Product Name	Twinwashers	TW3/8"spss
Product Code	Item Number	2076
VPE	Number Per Package	200 Pcs.
	Materials	Steel EN 1.7182
De	Outer Diameter (mm)	21,0
Di	Inner Diameter (mm)	10,3
t	Material Thickness (mm)	2,0

Standart
DIN 25201

Alternative Materials
Steel EN 1.7182
Stainless Steel EN 1.4404

