

# tiefastener®

USE THE BEST

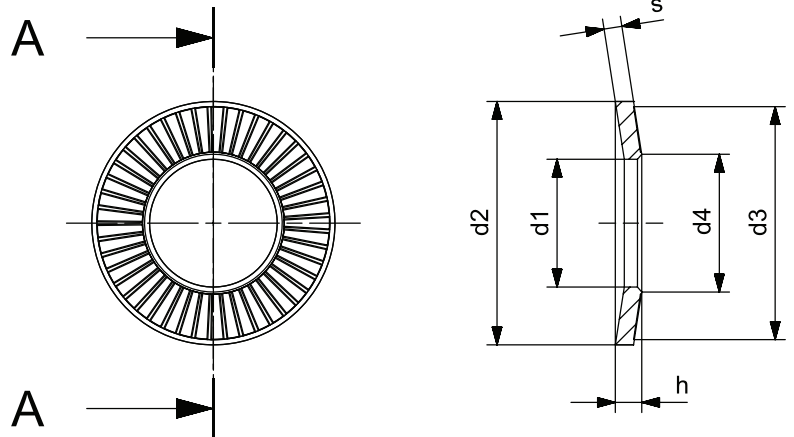
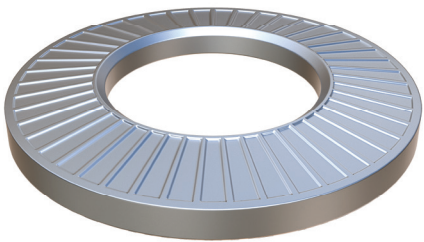

SECTION A-A

## Technical Specifications

Product Name	NFE 25511	Narrow Type - M4
Product Code	Item Number	401101
VPE	Number Per Package	500 Pcs.
	Materials	Carbon Steel C60S
d1 min. - max.	Inner Diameter (mm)	4,10 - 4,40
d2 min. - max.	Outer Diameter (mm)	7,71 - 8,29
s min. - max.	Material Thickness (mm)	0,77 - 0,83
H min. - max.	Total Thickness (mm)	1,00 - 1,20
d4 min. - max.	Inner Dia. of Knurl (mm)	4,70 - 5,20
d3 min.	Outer Dia. of Knurl (mm)	7,00
	Number of Knurl	32

Standart  
NFE 25-511

### Alternative Materials

\*Carbon Steel C60S DIN EN 10132, hardness 420-510 Hv 10 after heat-treatment for hardening and tempering

\*Stainless Steel AISI 304 (InoxA2) EN 10088, No1.4301 cold rolled at high resistance.

\*Stainless Steel AISI 316 (InoxA4) EN 10088, No1.4401 cold rolled at high resistance.