

tiefastener®

USE THE BEST

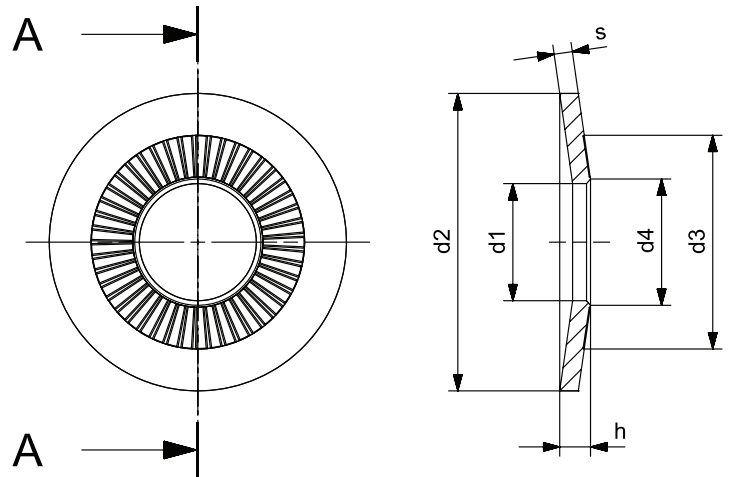
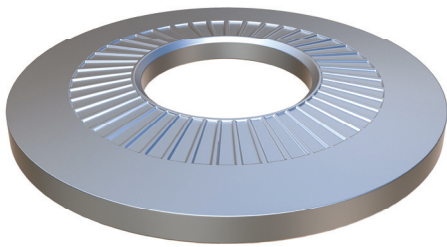

Technical Specifications

Product Name	NFE 25511	Large Type - M12
Product Code	Item Number	402106
VPE	Number Per Package	50 Pcs.
	Materials	Carbon Steel C60S
d1 min. - max.	Inner Diameter (mm)	12,40 - 12,83
d2 min. - max.	Outer Diameter (mm)	31,50 - 32,50
s min. - max.	Material Thickness (mm)	1,95 - 2,05
H min. - max.	Total Thickness (mm)	3,10 - 3,60
d4 min. - max.	Inner Dia. of Knurl (mm)	13,70 - 14,40
d3 min.	Outer Dia. of Knurl (mm)	18,00
	Number of Knurl	45

Standart
NFE 25-511

Alternative Materials

*Carbon Steel C60S DIN EN 10132, hardness 420-510 Hv 10 after heat-treatment for hardening and tempering

*Stainless Steel AISI 304 (InoxA2) EN 10088, No1.4301 cold rolled at high resistance.

*Stainless Steel AISI 316 (InoxA4) EN 10088, No1.4401 cold rolled at high resistance.