

tiefastener®

USE THE BEST

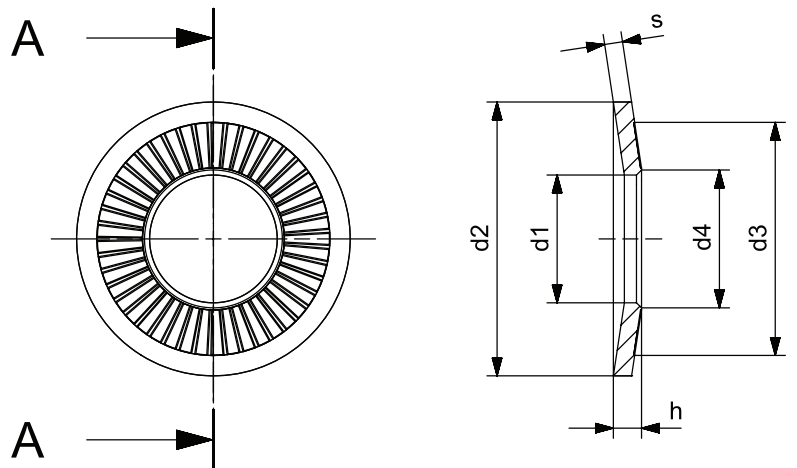
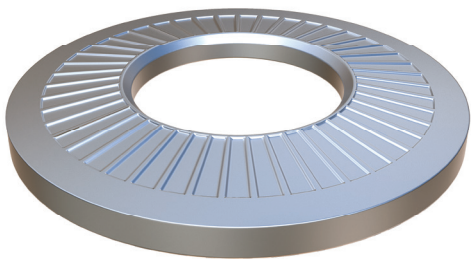

SECTION A-A

Technical Specifications

Product Name	NFE 25511	Medium Type - M20
Product Code	Item Number	403109
VPE	Number Per Package	50 Pcs.
	Materials	Carbon Steel C60S
d1 min. - max.	Inner Diameter (mm)	20,50 - 21,02
d2 min. - max.	Outer Diameter (mm)	39,50 - 40,50
s min. - max.	Material Thickness (mm)	3,14 - 3,26
H min. - max.	Total Thickness (mm)	4,30 - 4,90
d4 min. - max.	Inner Dia. of Knurl (mm)	22,80 - 23,10
d3 min.	Outer Dia. of Knurl (mm)	24,00
	Number of Knurl	60

Standart
NFE 25-511

Alternative Materials

*Carbon Steel C60S DIN EN 10132, hardness 420-510 Hv 10 after heat-treatment for hardening and tempering

*Stainless Steel AISI 304 (InoxA2) EN 10088, No1.4301 cold rolled at high resistance.

*Stainless Steel AISI 316 (InoxA4) EN 10088, No1.4401 cold rolled at high resistance.