

# tiefastener<sup>®</sup>

USE THE BEST

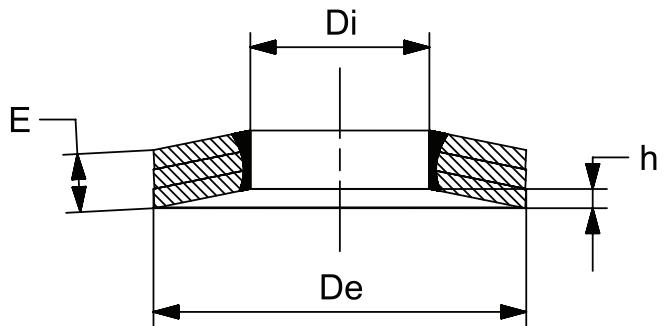
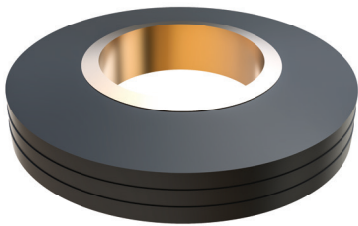

## Technical Specifications

Product Code	Item Number	501101
VPE	Per 1000 pcs. in kg	5.60
	Materials	Carbon Steel C60S
De	Outer Diameter (mm)	20,00
Di	Inner Diameter (mm)	8,50
E	Material Thickness (mm)	2,80
h	Stroke (mm)	0,95
	Test Load (DaN)	400
	h After test	0,70
	Screw Size	M8

Description  
TIESPRING 3L

### Alternative Materials

\*Carbon Steel C60S DIN EN 10132, hardness 420-510 Hv 10 after heat-treatment for hardening and tempering

\*Stainless Steel AISI 304 (InoxA2) EN 10088, No1.4301 cold rolled at high resistance.

\*Stainless Steel AISI 316 (InoxA4) EN 10088, No1.4401 cold rolled at high resistance.