

tiefastener[®]

USE THE BEST

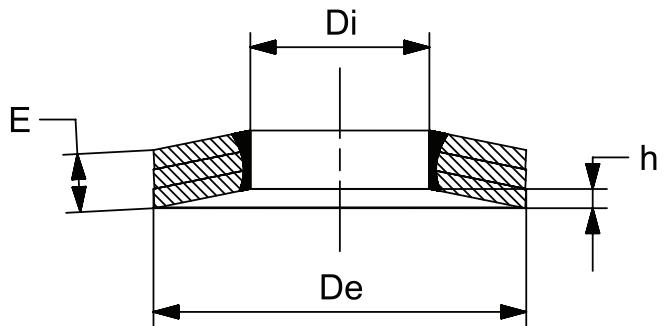
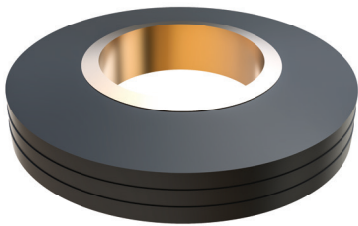

Technical Specifications

| | | |
|--------------|-------------------------|-------------------|
| Product Code | Item Number | 501104 |
| VPE | Per 1000 pcs. in kg | 18,00 |
| | Materials | Carbon Steel C60S |
| De | Outer Diameter (mm) | 29,00 |
| Di | Inner Diameter (mm) | 15,50 |
| E | Material Thickness (mm) | 4,80 |
| h | Stroke (mm) | 1,30 |
| | Test Load (DaN) | 1300 |
| | h After test | 0,90 |
| | Screw Size | M14 |

Description
TIESPRING 3L

Alternative Materials

*Carbon Steel C60S DIN EN 10132, hardness 420-510 Hv 10 after heat-treatment for hardening and tempering

*Stainless Steel AISI 304 (InoxA2) EN 10088, No1.4301 cold rolled at high resistance.

*Stainless Steel AISI 316 (InoxA4) EN 10088, No1.4401 cold rolled at high resistance.