

tiefastener[®]

USE THE BEST

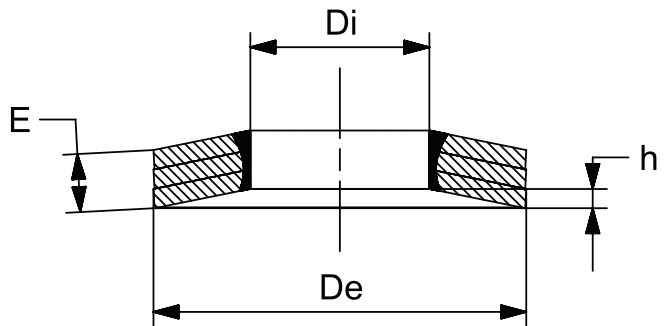
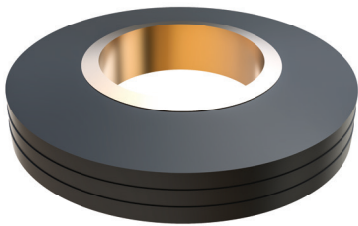

Technical Specifications

Product Code	Item Number	501109
VPE	Per 1000 pcs. in kg	81.00
	Materials	Carbon Steel C60S
De	Outer Diameter (mm)	50,00
Di	Inner Diameter (mm)	25,00
E	Material Thickness (mm)	7,20
h	Stroke (mm)	1,84
	Test Load (DaN)	2900
	h After test	1,60
	Screw Size	M24

Description
TIESPRING 3L

Alternative Materials

*Carbon Steel C60S DIN EN 10132, hardness 420-510 Hv 10 after heat-treatment for hardening and tempering

*Stainless Steel AISI 304 (InoxA2) EN 10088, No1.4301 cold rolled at high resistance.

*Stainless Steel AISI 316 (InoxA4) EN 10088, No1.4401 cold rolled at high resistance.