

# tiefastener<sup>®</sup>

USE THE BEST

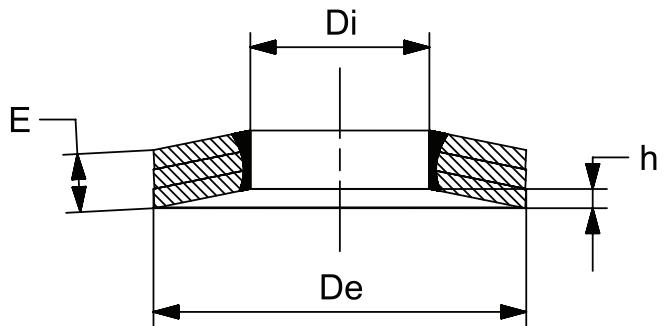
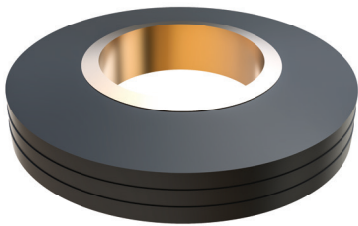

## Technical Specifications

Product Code	Item Number	501114
VPE	Per 1000 pcs. in kg	223.00
	Materials	Carbon Steel C60S
De	Outer Diameter (mm)	72,00
Di	Inner Diameter (mm)	41,00
E	Material Thickness (mm)	10,00
h	Stroke (mm)	2,45
	Test Load (DaN)	5500
	h After test	2,20
	Screw Size	M39

Description  
TIESPRING 3L

### Alternative Materials

\*Carbon Steel C60S DIN EN 10132, hardness 420-510 Hv 10 after heat-treatment for hardening and tempering

\*Stainless Steel AISI 304 (InoxA2) EN 10088, No1.4301 cold rolled at high resistance.

\*Stainless Steel AISI 316 (InoxA4) EN 10088, No1.4401 cold rolled at high resistance.