

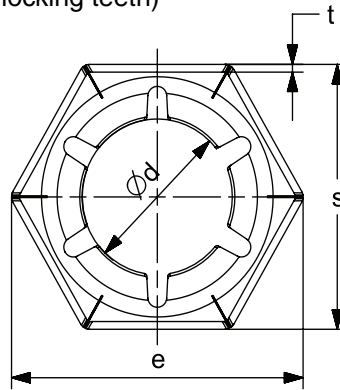

For metric thread Series 1  
(6 locking teeth)

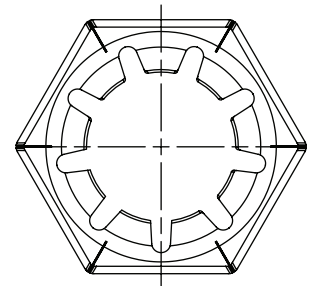

For metric fine thread  
Series 2 and 3 (9 locking teeth)



## Technical Specifications

Product Code	Item Number	800108	
Nominal thread diameter	Nom. size (series1)	M18	
	Special size (series2)	M18x2,00	
	Special size (series3)	M18x1,50	
Diameter d1	Serie 1 (mm)	15,50	
	Serie 2 (mm)	16,20	
	Serie 3 (mm)	16,80	
Dimensions of the hex	e (mm)	-	31,20
	s (mm)	h13	27,00
m	Height (mm)	5,50	
Other dimensions	t (mm)	Serie 1	0,70
		Serie 2	0,70
		Serie 3	0,70
	u (mm)	(min.)	5,50
	v (mm)	(min.)	20,50

**Standart**  
DIN 7967

### Alternative Materials

-Carbon Steel C60S DIN EN 10132, hardness 420-510 Hv 10 after heat-treatment for hardening and tempering  
-Stainless Steel AISI 316 (InoxA4) EN 10088, No1.4401 cold rolled at high resistance.