

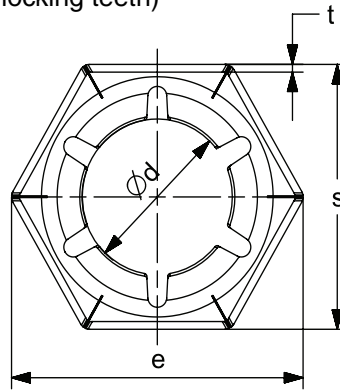

For metric thread Series 1
(6 locking teeth)

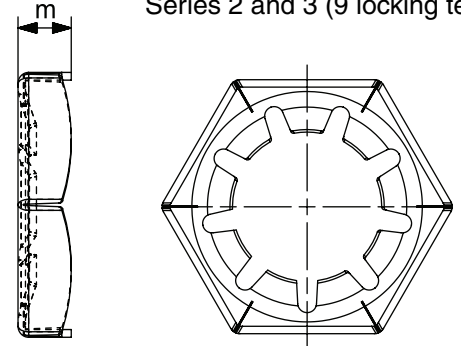

For metric fine thread
Series 2 and 3 (9 locking teeth)



Technical Specifications

Product Code	Item Number	800114	
Nominal thread diameter	Nom. size (series1)	M33	
	Special size (series2)	M33x2,00	
	Special size (series3)	-	
Diameter d1	Serie 1 (mm)	29,80	
	Serie 2 (mm)	31,50	
	Serie 3 (mm)	-	
Dimensions of the hex	e (mm)	-	57,70
	s (mm)	h13	50,00
m	Height (mm)	8,00	
Other dimensions	t (mm)	Serie 1	1,20
		Serie 2	1,00
		Serie 3	-
	u (mm)	(min.)	8,00
	v (mm)	(min.)	34,00

Standart
DIN 7967

Alternative Materials

-Carbon Steel C60S DIN EN 10132, hardness 420-510 Hv 10 after heat-treatment for hardening and tempering
-Stainless Steel AISI 316 (InoxA4) EN 10088, No1.4401 cold rolled at high resistance.