

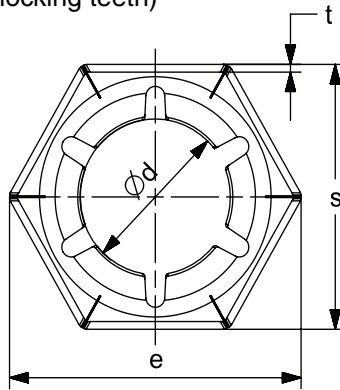

For metric thread Series 1
(6 locking teeth)

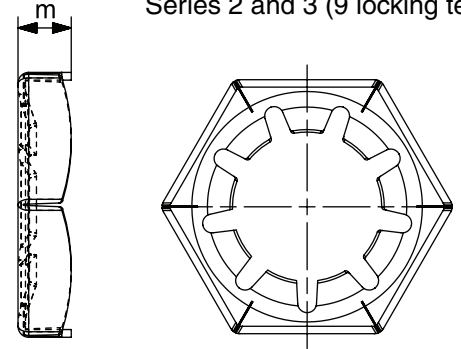

For metric fine thread
Series 2 and 3 (9 locking teeth)



Technical Specifications

Product Code	Item Number	800117	
Nominal thread diameter	Nom. size (series1)	M42	
	Special size (series2)	M42x3,00	
	Special size (series3)	-	
Diameter d1	Serie 1 (mm)	37,60	
	Serie 2 (mm)	39,80	
	Serie 3 (mm)	-	
Dimensions of the hex	e (mm)	-	75,00
	s (mm)	h13	65,00
m	Height (mm)	11,00	
Other dimensions	t (mm)	Serie 1	1,40
		Serie 2	1,40
		Serie 3	-
	u (mm)	(min.)	11,00
v (mm)	(min.)	45,00	

Standart
DIN 7967

Alternative Materials

-Carbon Steel C60S DIN EN 10132, hardness 420-510 Hv 10 after heat-treatment for hardening and tempering
-Stainless Steel AISI 316 (InoxA4) EN 10088, No1.4401 cold rolled at high resistance.